

Development of an innovative measurement system for audible noise monitoring of OHL

**Uwe Schichler, W. Troppauer,
B. Fischer, T. Heine, Klemens Reich,
M. Leonhardsberger & O. Oberzaucher**

**e & i Elektrotechnik und
Informationstechnik**

ISSN 0932-383X

Elektrotech. Inftech.

DOI 10.1007/s00502-018-0670-z



Development of an innovative measurement system for audible noise monitoring of OHL

U. Schichler OVE, W. Troppauer, B. Fischer, T. Heine, K. Reich OVE, M. Leonhardsberger OVE, O. Oberzaucher

Austrian Power Grid (APG), the main TSO of Austria, uses different approaches to face challenges arising from stricter requirements regarding environmental issues, where audible noise (AN) is one of the important topics in this context.

A innovative approach is pursued with a newly developed measurement system for audible noise monitoring of OHL. The main component of this system is an "optical microphone". The main benefit compared to a conventional capacitive-microphone, is the lack of any metal and moving parts. Thus, it can operate in the proximity of high electric fields without interferences. This opens up new possibilities for AN measurement on energized OHL. That facilitates the direct measurement of the acoustic immissions and not only the emissions.

This is an advantage due to the fact, that measuring AN with conventional microphones has several limitations. The emitted noise from OHL is low compared to other emitters in the surroundings (cars, animals, farming, airplanes) and dependant on wind strength and direction and hence difficult to measure. Furthermore, there is the need for a place on the ground to set up the microphones and the power supply. An agreement with the landowners is mandatory.

For the operation of the optical microphone additional components are necessary. A special suspension system was developed to mount the sensor head in the direct vicinity of a conductor. One requirement for the suspension is to keep the sensor head at an exact position underneath the conductor. In a close distance to the conductor, noise emissions vary in a wide range if the relative position is not properly fixed. The second requirement is that the suspension system itself doesn't influence the measurement. This means, that the electric field strength, which is a main parameter for AN, remains unchanged in the presence of the suspension system.

The paper will present the solutions and innovations that have been developed, laboratory tests and installation methods to mount the optical microphone on a conductor.

Keywords: overhead line; corona; audible noise measurement; monitoring

© CIGRE - Reprint from www.cigre.org with kind permission 2018



1. Introduction

In Austria there is no legal threshold value for AN from OHL, as for example with railways, streets or airports. Therefore, for every permission procedure, a case-by-case examination is necessary. Over time a certain methodology has been developed to counter this problem. Another issue is that nowadays people have become more sensitive regarding noise pollution. In this context AN emitted by existing OHL has come more to the attention by residents, even though they had already been previously living in the vicinity of an overhead line, some others even decided to move there.

APG and partners have initiated a project called 'innovation-section', which is a test run for new technical innovations to meet persistent challenges [1]. This innovation-section is a 1,2 km long part of an existing 380 kV double circuit line in Austria, which was rebuilt in 2016 from a standard OHL design to an insulated cross-arms design and new conductors with special construction and treated surface.

1.1 Issues regarding conventional AN measurements

AN-measurements are performed for three reasons.

- Due to constant complaints from neighbours of an OHL. In this case the AN measurement shall approve, that the OHL in question is not louder than other comparable OHLs.
- Comparative measurement before and after a refurbishment of an OHL. Such measurements shall approve, that the refurbished

OHL is not louder than calculated in the forecast (e.g. part of EIA permitting procedures).

- Long term measurements for scientific use (to obtain a better understanding of the acoustic behaviour of OHLs).

AN measurements in the open field faces several factors, that can heavily influence the outcome of the AN analysis.

First off, an agreement with the landowner of the area where the measurement should be performed has to be found. If the measurement is done for the landowner, this should not be a problem. In other cases this can lead to high compensations or the need for a relocation of the measurement point.

The dependency of a power supply near to the measurement setup is another issue. For a long term measurement this means, that either a battery supply has to be changed in certain intervals or some kind of infrastructure is in the surroundings, which implies problems with the selfnoise generated by this infrastructure.

Paper submitted for the CIGRE Session 2018, SC B2, Paris, France, August 26–31, 2018.

Schichler, Uwe, Graz University of Technology, Graz, Austria; **Troppauer, W.**, Mosdorfer, Weiz, Austria; **Fischer, B.**, XARION Laser Acoustics, Wien, Austria; **Heine, T.**, XARION Laser Acoustics, Wien, Austria; **Reich, Klemens**, Austrian Power Grid AG, Wagramer Straße 19, 1220 Wien, Austria (E-mail: klemens.reich@apg.at); **Leonhardsberger, M.**, Austrian Power Grid AG, Wien, Austria; **Oberzaucher, O.**, Austrian Power Grid AG, Wien, Austria

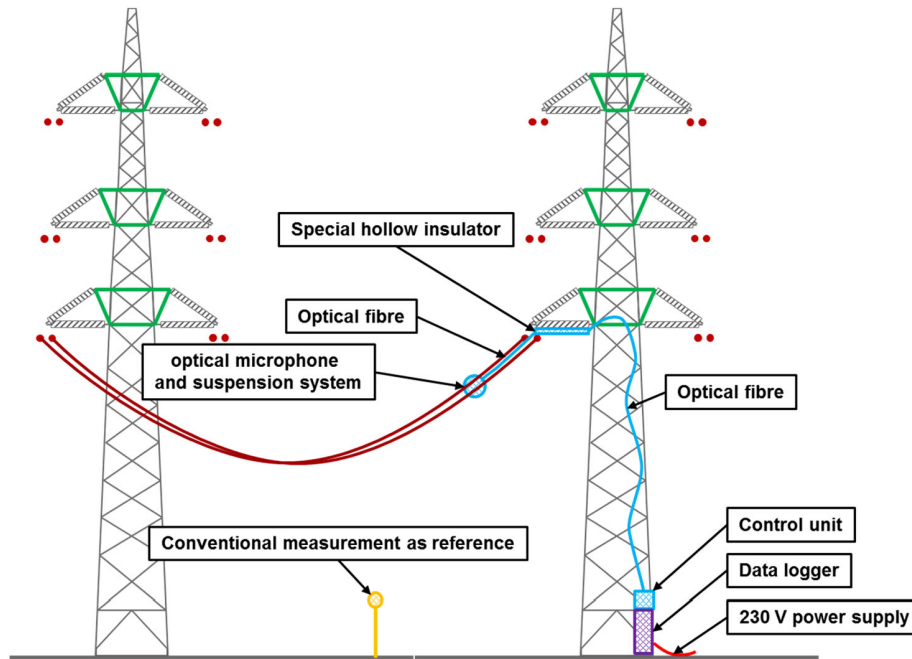

Fig. 1. Principle sketch of the of the measurement setup

AN that is not caused by the overhead line itself is the biggest issue for a conventional measurement setup. Examples are numerous: streets, railways, animals, creeks, farming or forests to list only a few. These external factors make an effortful analysis of the data necessary, to make sure that the outcome is not tampered. The bigger the distance to the source of interest, in this case the OHL, the bigger the influence of external AN is. In theory, the sound level of external interferences should at minimum be 10 dBs lower than that of the source, to ensure the independency of the measurement [2]. Considering a sound level of approximately 55 dB(A) underneath a OHL (distance of around 10 m to the conductors), the sound level of other sources at the measurement point shouldn't be louder than 45 dB(A), which is very unlikely in the long term. For example, the background noise of the rain itself is often around 45 dB(A).

To handle the mentioned problems there are some possible ways to encounter them. The measurement points have to be chosen very wisely. Furthermore it is recommended to use multiple sound level meters at different locations to compensate external sound interferences and the influence of wind direction and speed. A typical example would be one sound level meter directly under the OHL, a second one in a distance of 30 m orthogonally to the line-axis and a third one in a distance of more than 100 m, to have a reference point for background noise and external interferences.

Typically an OHL only generates substantial AN under bad weather conditions e.g. rain, fog or hoarfrost. Hence, for any kind of measurement setup it is required to measure for a longer period of time. The minimum measurement time at APG is one week, often an extension to two weeks is required.

2. New approach for audible noise measurement

In the next step the innovation-section will be enhanced with a newly developed measurement-system for audible noise monitoring of OHL. The main component of this system is a "membrane-free optical microphone". The project has started in 2014 and the field

test is scheduled for 2018 and will bring valuable comparisons between conventional and the optical microphone.

The main benefit of the optical microphone, compared to a conventional capacitive-microphone, is the lack of any metal and moving parts. The absence of moving parts (such as a membrane, e.g.) allows to extend the measurement range into the ultrasound regime. The absence of metallic parts, on the other hand, means that it can operate in the proximity of high electric fields without interferences. This opens up new possibilities for AN measurement on energized OHL, as the microphone can be placed within only a few dozen centimetres of the conductor. That facilitates the direct measurement of the acoustic immissions and not only the emissions.

The control unit of the optical microphone is connected with data logger by optical fibre. The logger continuously saves and transmits the collected data at the base of the tower. There the data is stored and can be read out anytime without switching off the line.

The optical microphone is mounted on a special suspension system on the conductor bundle. The optical fibre, which transmit the data, is connected through a special hollow insulator to the tower. From the center of the tower the optical fibre is conducted to the bottom where the control unit and the data logger are situated. A permanent power supply with 230 V is mandatory for the control unit.

The whole arrangement of the measurement setup can be seen in Fig. 1.

3. Technical description of the optical microphone

The optical microphone works on the principle of interferometry and consists of a control unit containing a laser which sends its light over an optical fibre to a sensor head. This sensor head consists of a pair of parallel, semi reflective mirrors. Due to the difference in the laser's wave velocity depending on the air density in the hollow sensor head, the interference of the reflected light wave gives direct and proportional information about the sound pressure level.

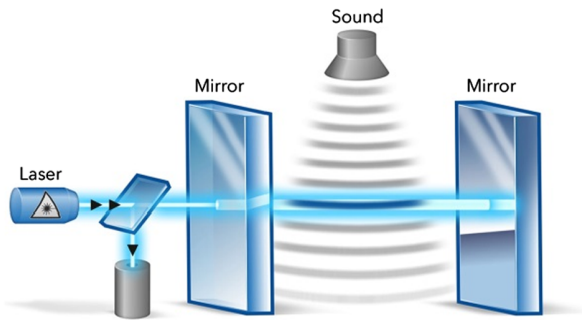

Fig. 2. Sketch of the setup of the membrane-free optical microphone with laser source and a pair of mirrors (etalon) for interferometric sound pressure measurements

Classical state-of-the-art microphones are a well-established technology with a history reaching back to the 1860s and Bells developments. Nowadays they are covering a wide range of applications from high end measurement equipment to very low price mobile phone devices benefitting from silicon-integrated technology.

The functional principle is based on sensitive electronic components which makes the use of such microphones close to high electric or magnetic fields impossible, as electric discharges would immediately damage the device. Furthermore oscillating electric fields would induce phantom signals into the wiring of the electric circuit of the microphone.

These limitations can be overcome by using an optical microphone as its sensor head consists of electrically non-conducting materials such as glass and plastic only. The acoustic signal is converted to an optical signal and is routed to the electronic system by means of an optical fiber immune to electromagnetic interference.

The sensing principle of an optical microphone relies on the one-way interaction of two wave phenomena: the sound wave influences an optical wave while the optical wave does not distort the acoustic sound field.

A sound wave is a compression wave of the air and thus a longitudinal pressure oscillation. The index of refraction of air is proportional to the pressure p of air and changes the wavelength of light λ transmitted through this medium. However these changes are pretty small:

$$\frac{\Delta\lambda}{\lambda} \approx 2 \cdot 10^{-9}/\text{Pa}$$

Nevertheless they can be detected by narrow linewidth lasers and the use of an interferometric measurement approach.

A laser, emitting at the telecom wavelength of 1550 nm, is connected to an optical fiber to a miniaturized laser interferometer (so-called etalon), consisting of two parallel mm-sized semi-transparent mirrors (refer to Fig. 2) firmly bond together via spacer elements.

Within the etalon a standing optical wave evolves. In case the half-wavelength of the laser is a multiple of the fixed length of the etalon the optical wave interferes constructively and the light intensity within the etalon is at its maximum. If this condition is not fully satisfied the intensity decreases.

The moment a sound wave enters the etalon, air pressure and thus wavelength of the laser light within the etalon oscillates. As a consequence, the interference condition and thus the light intensity varies. By selecting the optimal point between constructive and destructive interference the pressure modulation is linearly transformed into an intensity modulation that can be easily detected by means of a photodiode.



Fig. 3. Compact sensor head of the optical microphone containing no metallic parts

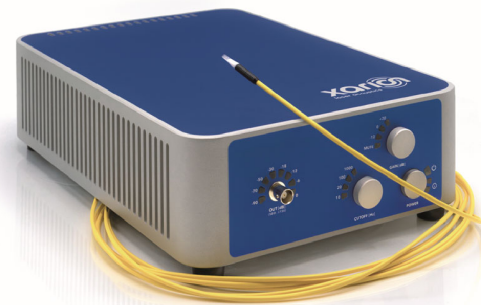

Fig. 4. Complete system including sensor head, optical fiber cable and the control and detection unit

In acoustics, only the alternating component of the pressure is of interest instead of the static pressure. Therefore the laser emission wavelength is stabilized to the etalon using a slow control circuit. Thereby, slowly varying quantities such as environmental pressure, temperature or even laser drift itself are compensated.

In state-of-the-art capacitive microphones, a membrane is deformed by the acoustic sound pressure. Due to inertia, this can only happen at finite speed. In other words: for high frequencies, a traditional microphone suffers from an increasing loss of sensitivity. For the membrane-free optical microphone, no mechanical movement is involved, therefore the detectable frequency range expands to the very high frequency range. Hence, the technology enables resonance-free, inherently linear signal detection over a broad bandwidth (10 Hz to 1 MHz) covering not only the audibility range of the human ear but also the entire ultrasound transmitted through air. This might be of high interest to better understand the various mechanisms of sound generation close to a high voltage conductor. It's well known that electric sparks are rather short events and thus emit broad frequency distributions ranging into far ultrasound.

The compact sensor head (refer to Fig. 3) is immune to electromagnetic interference and can be operated close to conductors of OHLs. Its connection to the electronic control and detection unit (refer to Fig. 4) is a fiber optic cable that can be very long. We have already realized 150 m for this OHL setup.

4. Technical description of the suspension of the microphone

4.1 Challenges

The suspension design was influenced by several factors. On one hand the optimal placement and sustainable service of the microphone near the energized overhead line conductor and on the other hand the trouble-free transmission of the measuring signals from the sensor head to the control unit. Another challenge was the inhospitable environment itself; the optical microphone must withstand the extreme electric and magnetic fields in the vicinity of an energized conductor.

4.2 Technical specification

Following minimum requirements for the design of the suspension system were specified:

- The sensor(s) have to be placed in an exact position relative to the conductor(s)
- The sensor(s) have to follow any movement of the conductor(s)
- No influence of the measurements from the suspension system itself
- Provide mechanical protection for the optical cable of the sensor(s)
- Work efficient under severe weather conditions for years, including snowfall and storm
- Low weight
- Resist all static and dynamic loads of an operating OHL
- Easy to install

4.3 Ideas – pro & cons

Based on the technical requirements, in total three concepts for a suspension systems had been formed and analysed to prove their feasibility.

Concept 1 was named "Sensor backpack". Between two spacers, which were attached to the conductor at a distance of a few meters, thin metallic wires should be tensioned. On these wires, the assembly of the sensors was considered. The concept was not pursued, since the assembly would be too complicated, but the decisive factor was the fact that this construction would have distorted the electric fields inadmissible, thus the measuring results would not be trustful.

Concept 2 was named "inverted T with boom". At a central mounting tube, an inverted T-shaped fastening element has to be fixed, which has additional booms on each side that are aligned with the conductor. The sensors should be placed at the ends of these cantilevered booms. Compared to Concept 1 these design was considered not do influence the measuring results but was classified to be too complicated in the installation and the final weight was considered to be too high.

Concept 3 was based on concept 2 but the additional booms were omitted in order to reduce the weight. Just the "inverted T" was kept as basis. This concept appeared most promising and was further developed, see Fig. 5.

4.4 Feasibility

The basic idea was a central support element, which on one hand is stiff enough not to sag and thus displace the sensor, on the other hand, not to influence the electric field. In addition, it should provide mechanical protection for the sensitive sensor connecting cable, based on optical fibre technology.

As the total length of the central support system was considered to be up to 10 m in length, where the "inverted T" sensor-holder is

placed in the middle, the sag is a critical parameter. Different materials and dimensions of tubes were calculated in term of sagging in order to find an optimal solution.

Finally an extruded glass fibre rod was considered as the best design. As the system should be weather resistant the tube was coated with a layer of silicone rubber to provide an adequate protection against UV radiation and to increase the performance in wet conditions.

4.5 First prototype

Based on the feasibility study a first prototype was manufactured and tested in a high-voltage laboratory under dry and wet conditions. For the wet tests a special irrigation-device was developed by the laboratory to provide an even rainfall on the test objective.

To improve the transport and installation performance, the length of each of the 3 tubes was limited to 3,5 m, finally connected via specially designed watertight connection clamps.

The complete 10 m section of the central support tube was placed in the centre of a horizontal twin bundle by the use of adapted articulated spacers. To stiffen the system each end of the central support system was equipped with two spacers.

4.6 Results

At higher voltage levels corona discharges occurred at the vertical cylindrical body of the "inverted-T" sensor holder. Additionally glowing points at the metallic connecting bolts of the watertight connection clamps as well as on the clamp of the "inverted T" were observed.

4.7 Modifications

To avoid any disturbances due to glowing points or corona discharges, all metallic parts were substituted by dielectrically material, used for the clamp bodies as well the connection bolts. The central body of the "inverted-T" sensor holder was equipped with silicone rubber insulation sheds in order to increase the electrical performance under wet conditions.

4.8 Final design of the suspension

With all these modifications the electrical tests under dry and wet conditions were repeated. The set-up had been extended by the installation of optical microphones, which have recorded active measuring sequences.

All electrical type tests for the central fixation system have been finished successfully.

In order to deliver the optical signal of the microphones potential-free to the splice box, which is placed at the tower foot, the existing insulated cross-arm has to be equipped with an additional special hollow composite insulator, see Fig. 6. This hollow insulator, which is equipped with special designed end fittings, is mounted parallel to the horizontal tension insulator of the insulated cross-arm. The optical fibre cable of the optic microphone is routed through the hollow core of the insulator, which is oiled filled after the routing, in order to reduce the electrical potential from 400 kV to harmless earth potential.

5. Audible noise measurement

5.1 Laboratory test setup

The main purpose of these tests was to assess and evaluate the behavior of optical microphones and the suspension design to be installed in the "innovation-section". It is supposed that characteristics obtained by testing of a single phase arrangement under surface

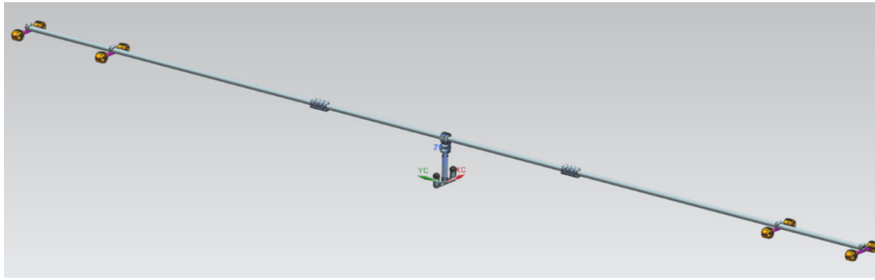

Fig. 5. Suspension system for the optical microphone

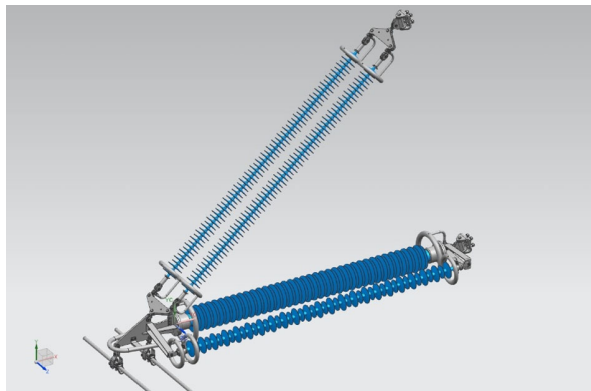

Fig. 6. Insulated cross-arms with hollow insulator for routing of the optical fiber

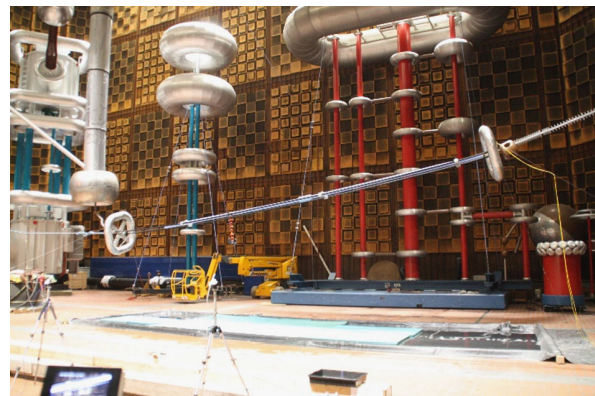

Fig. 7. Laboratory test setup for audible noise measurements on OHL conductors

field magnitudes of the same order as to be expected under conditions on site. This was achieved with a ground clearance of 3 m at a voltage level in the range of 180–220 kV. This setup gave the opportunity to manipulate the arrangements easily, so the whole measurement program at Graz University of Technology could be achieved within short time.

The new developed conductor LWC AAAC 604 of the existing line ('innovation section') were used for the audible noise (AN) and partial discharge (PD) measurements under wet conditions. A bundle of twin conductors (400 mm spacing) with treated surface (black hydrophilic coating) was used for the experiments in high voltage laboratories.

Figure 7 shows the laboratory test setups for AN measurements on OHL conductors. The main dimensions of the different test setups, the performed measurements and instrumentation for AN measurement and artificial rain were as follows:

- conductor length: 10 m
- height of conductor bundle above ground: 3 m
- distance to walls and other equipment in the laboratory: > 5,5 m
- measurements: AN, Radio Interference Voltage (RIV), Partial Discharge (PD), visual inspection: corona camera, digital camera
- number of conventional microphones: 4 with the closest one at a distance of 6 m; multichannel system which enabled continuous sound pressure level measurement with digital data saving and post processing.
- rain: pre-wetting, constant artificial rain with rainfall rate: 1–15 mm/h

A proven test procedure offers AN measurement in dependence from the test voltage resp. conductor surface gradient [3]. The test

voltage range has to cover at least all conductor surface gradients which will exist on the OHL in service. An application of different rainfall rates can support the characterization of the whole setup.

Test parameters for audible noise measurement dependent on voltage resp. conductor surface gradient

- constant artificial rain with defined rainfall rate, e.g. 6 mm/h
- range of test voltage in relation to bundle height above ground and rated voltage of OHL, e.g. 120–260 kV
- stepwise increase of test voltage, voltage steps and time of each voltage step: e.g. 10 kV, 30 s (5 s voltage ramp, 25 s constant voltage)

The laboratory test proved, that the final suspension design doesn't influence the AN measurement. There were no discharges on the central support tube, nor on the inverted T, as can be seen in Fig. 8.

The results of the AN measurements of the optical microphones and the conventional microphones compared very well. Therefore the measurement results of the conventional sound meters had to be extrapolated due to the higher distance to the conductors.

5.2 Laboratory test with optical microphone

The laboratory measurements were performed with an optical microphone with a 60 m long optical fiber cable to route it along the conductor and to the control room. The sensitivity of the system was 10 mV/Pa with an A-weighted selfnoise of 55 dB(A) SPL and a frequency range of 1 MHz. With an updated version of the microphone a selfnoise of below 50 dB(A) SPL is reached.

The A-weighted sound pressure level integrated over 125 ms was recorded. Due to the irrigation from time to time water drops hit

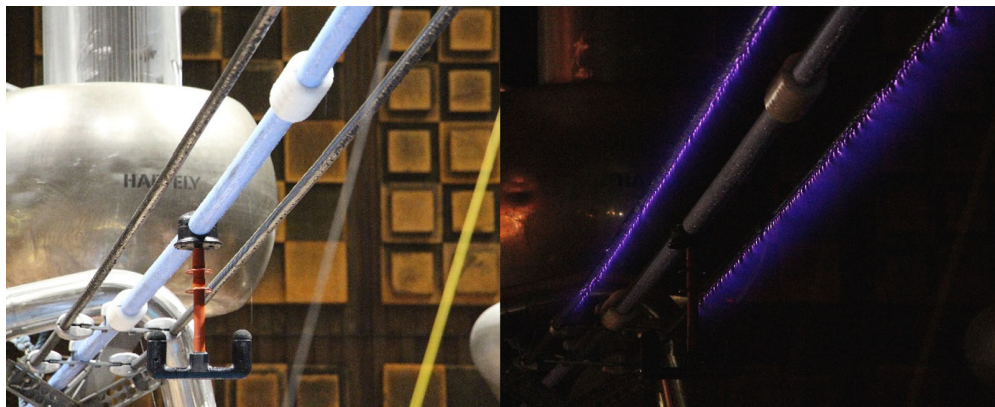

Fig. 8. Laboratory Test setup; left: close up of the suspension design; right: close up of the energized setup (note the lack of any discharges on the suspension)

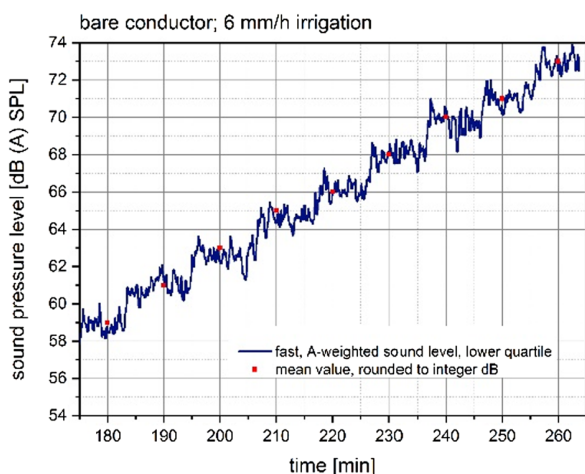

Fig. 9. A-weighted sound pressure level over time, as voltage was gradually increased

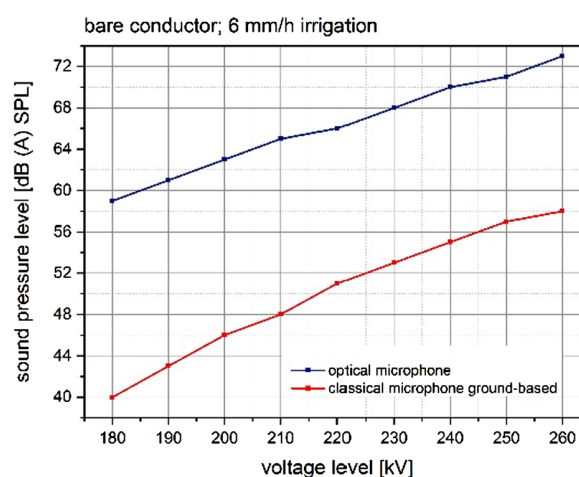

Fig. 11. Comparison of the classical measurement (emission) and optical microphone approach (immission) close to the conductor

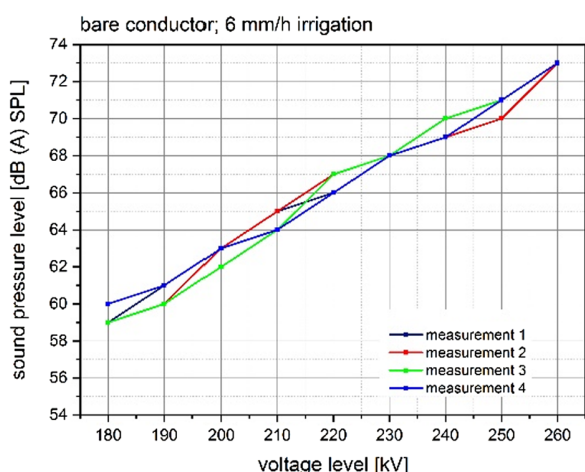

Fig. 10. Comparison of four independent measurements

the microphone weather protection shield and caused high sound pressure peaks. To eliminate these parasitic events only the lower

quartile of the data was taken into account. To further reduce data and to increase clarity of the graphs, the mean values rounded to integer dB values were evaluated. Figure 9 shows a voltage stepping from 180 kV to 260 kV and the corresponding sound pressure levels. Each voltage level was applied for 25 s to the conductor.

To prove the reproducibility of the measurement results of the complete measurement setup with the optical microphone, the same test procedure was done four times consecutively. These independent measurements showed very similar results (refer to Fig. 10).

Parallel to the immission measurements 40 cm close to the conductor using the optical microphone, a classical microphone (Gras, 1/2", Type: 850-1 SG) was positioned in a distance of 6 m from the conductor to perform emission measurements in parallel. The microphone was mounted in a height of 1,5 m. The measurement results are compared in Fig. 11.

Obviously the sound pressure levels close to the conductor are much higher than in the far field. Thus the immission measurement is much less sensitive to disturbing emissions in the surrounding (cars, animals, farming, airplanes) and wind strength and direction.

One of the major aims of the laboratory investigations was to compare two types of conductors: a new bare 39 mm diameter

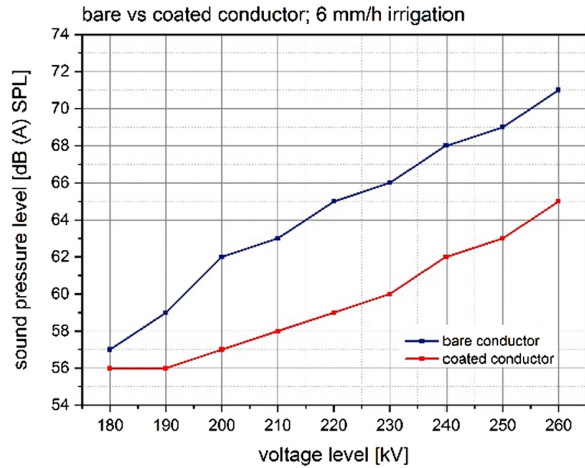

Fig. 12. Sound immission of a bare conductor compared to a coated one. The sound pressure level was substantially reduced

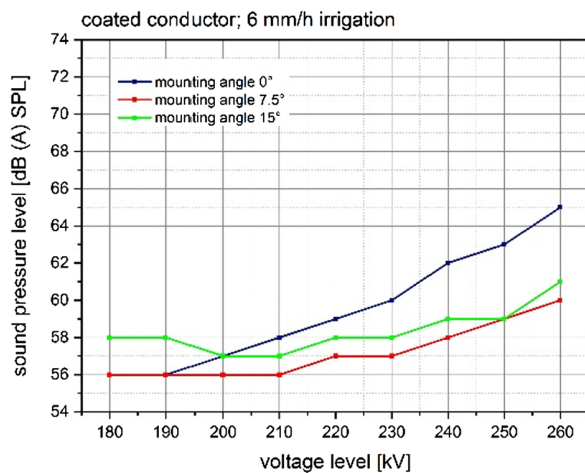

Fig. 13. Dependence of sound pressure level over voltage for the coated conductor at various mounting angles

conductor (LWC AlMgSi 604-HFAL5) and a conductor of the same type coated with a hydrophilic black color. The coating reduced the sound pressure level considerably, especially at higher voltage levels (refer to Fig. 12). For voltage levels below 200 kV the reading for the coated conductor is limited by the selfnoise level of the optical microphone.

A OHL-span is sagging between two poles. This was simulated in the laboratory by mounting the conductor testsection (10 m) at three different angles: 0°, 7.5° and 15°. While the blank conductor did not show much of a difference regarding sound immission

the coated conductor behaved quite differently at the three mounting angles (refer to Fig. 13). This effect can be interpreted as follows: On the hydrophobic surface of the bare conductor the water droplets maintained their position even at the high angles, while the water droplets on the hydrophilic surface of the coated conductor were running off the length of conductor very quickly at higher angles. Hence there were fewer droplets on the conductor causing lower immissions. Experimentally the higher angles were quite complicated to prepare. The graph shows difficulties for the 15° mounting angle where the sound pressure level was dominated by unintended humming noise from the end of the short conductor test section over almost the complete voltage stepping range.

6. Conclusion

Conventional audible noise measurements suffer from various drawbacks, such as influence by ambient noise that is not caused from the OHL itself.

A newly developed membrane free optical microphone offers an innovative approach to encounter the issues of standard sound level meters and give the opportunity to mount this new device in the direct vicinity of a conductor. The optical microphone works on the principle of interferometry and has advantages such as a sensor head without conductive and moving parts, which is connected to a control unit via an optical fibre. Therefore, it is possible to use it in the presence of high electric and magnetic fields.

The suspension design for the mounting of the optical microphone on the conductor has to fulfil critical technical requirements such as: not to influence the measurement itself, the placement of the sensors in an exact position relative to the conductors and being robust and easy to install.

The whole setup was tested in a high voltage laboratory. Multiple test runs were necessary, to find a working solution for the optical microphone and the suspension design. Finally, the whole setup was successfully tested. The results of the measurement with the optical microphone compared well to the expected values, derived from the parallel measurements with conventional sound meters.

Long term field tests of the whole setup are scheduled for 2018. Additionally an energy harvester for the control unit and data logger is under development. In this case, a unique solution is necessary due to the high power demand of the whole system.

References

- Schichler, Reich, Hadinger, Troppauer, Babuder, Vizintin, Leonhardsberger, Schmuck, Husman (2016): Innovation-section: test-run for upgrading a 220 kV OHL to 380 kV using insulated cross-arms and coated conductors. In CIGRE session Paris, report B2-301.
- IEC 61672-1:2013 Electroacoustics – sound level meters – part 1: specifications (IEC 61672-1:2002)
- Pischler, S. (2017): Influence of the conductor surface on OHL audible noise under foul weather conditions. In 20th international symposium on high voltage engineering, Buenos Aires, Argentina, Report 535.