

HD2003, HD2003.1



HD2003 - HD2003.1 THREE AXIS ULTRASONIC ANEMOMETER

HD2003 and HD2003.1 are three axis ultrasonic anemometers, they measure the speed and direction of wind, the U-V-W Cartesian components of speed, wind gust, sound speed and sonic temperature. The HD2003 allows also to detect temperature and relative humidity of the air and barometric pressure.

The HD2003 main features are:

- Determination of the anemometric quantities represented in diverse measurement units: wind speed and direction, U-V-W Cartesian components of speed, wind gust, sound speed, sonic temperature.
- (HD2003 Model) additional output quantities: Temperature, Relative Humidity and Pressure.
- 5 analogue voltage or current outputs, with different measuring ranges.
- Up to 12 further analogue current or voltage outputs, with different measuring ranges.
- 5 Serial Communication interfaces: RS232, RS422, RS485 MODBUS-RTU, RS485 Multidrop Communication Mode and AoXnd
- Configurable output rate of digital output data string.
- Configurable average periods 1÷60sec and 1÷60min. for all output quantities.
- Algorithmic raw data processing and validation, assuring $\pm 1\%$ precision to anemometric quantities.
- Digital high frequency data acquisition mode with 50Hz data output, or high frequency analogue data acquisition within 5Hz and 20Hz.
- Self-diagnosis with error checking and report.
- Reliability and precision on whole measuring range, no additional calibration required.
- Flexible, easy-to use demo software, configurable according to the user's needs through Computer interface.
- User interface for 'Setup' management and software upgrade through RS232 or RS485.
- Automatic alignment to the magnetic North through built in compass.
- No moving part, with reduced maintenance and service costs.
- Rugged and reliable structure, suitable for continuous operation even in severe environmental conditions.

- Low power consumption.
- (On request) Heaters Option: built-in heating device of sonic transducers, to prevent ice and snow formation. Assures correct measurements even in presence of sleet or snow.
- (On request) RS422 Option: full duplex 4-wire integrated circuit for RS422 communication.

Main applications:

- Meteorology
- Aviation and Navigation
- Tunnels, Highways
- Climatology
- Sport and winter stations
- Safety in yards
- Construction/Crane safety
- Industrial buildings

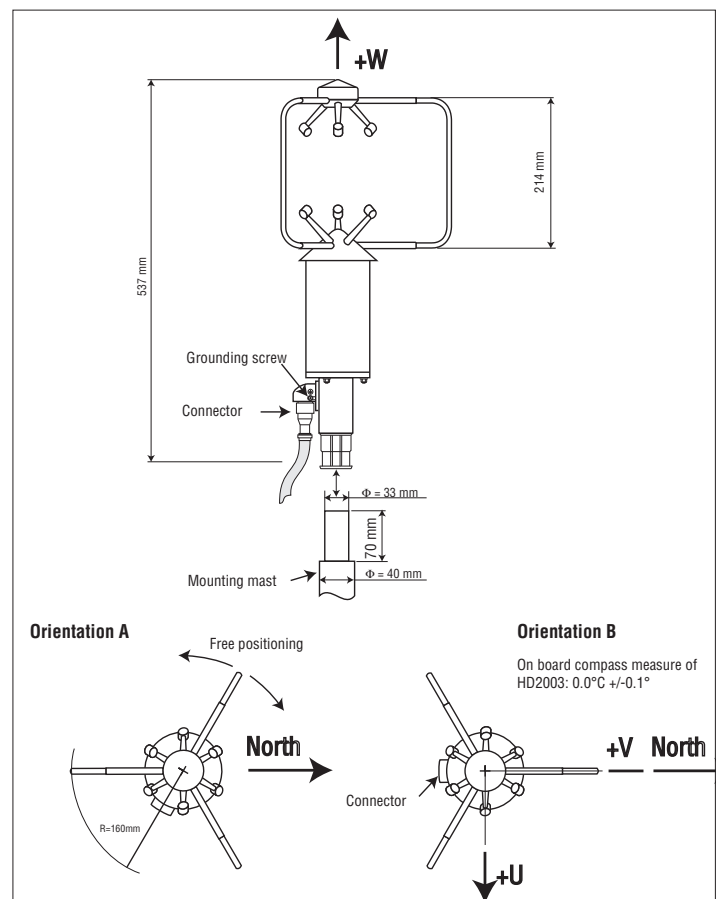
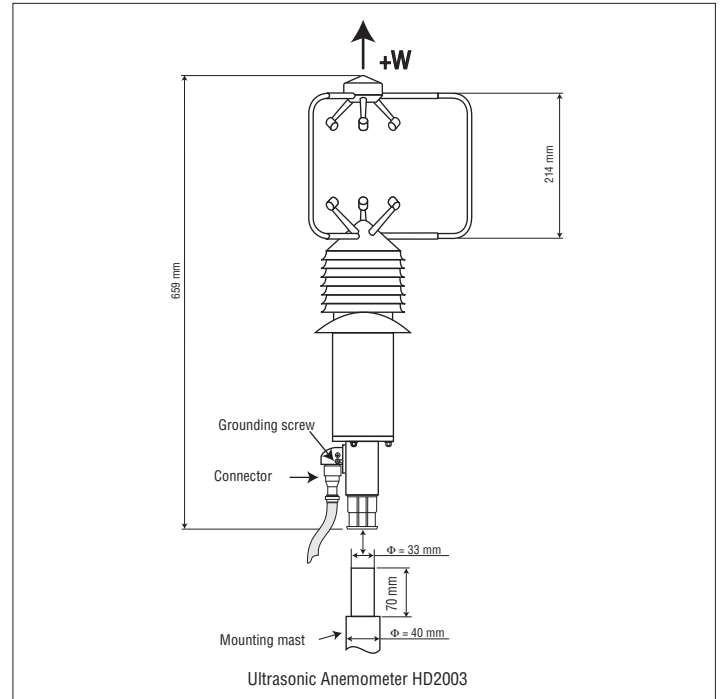

Technical specifications:

Output quantities	
Anemometric	Wind speed and direction, U-V-W components, sound speed, sonic temperature
Meteorological	(HD2003 Model) Pressure, Temperature, Relative Humidity
Heading	Compass with magnetic azimuth
Moving averages	1÷60 sec / 1÷60 min
Ultrasonic rate	60Hz
Wind speed	
Unit	m/s, cm/s, km/h, knots, mph
Range	0 ÷ 70 m/s (252 km/h)
Resolution	0.01 m/s
Accuracy	± 1% of reading
Wind direction	
Range	Azimuth: 0 ÷ 360° Elevation: ± 60°
Resolution	0.1°
Accuracy	± 1°
Sound Speed	
Range	300 ÷ 380 m/s
Resolution	0.01 m/s
Accuracy	± 1% of reading
Sonic Temperature	
Range	-40 +60°C
Resolution	0.1 °C
Accuracy	± 1 °C
Compass	
Range	0÷3600 /10°
Resolution	0.1°
Accuracy	± 1°
Digital Outputs	
Quantities	Anemometric and compass. (HD2003 Model) Pressure, Temperature, Relative Humidity
Communications	RS232 and RS422 full duplex, RS485 MODBUS-RTU, RS485 Multidrop and AoXnd half duplex
Baud rate	9600 ÷ 115200 bit/sec
Output Rate	Normal mode (Slow): 1 ÷ 3600 sec Digital High Frequency (Fast): fixed 50Hz
Analog Outputs	
Quantities	5 to be selected from output quantities (anemometric, compass, meteo).
Range	0-20mA, 4-20mA, 0÷1V, 0÷5V, 0÷10V, 1÷5V
Resolution	14 bits max
Analog Outputs Extended (With ICP DAS I-7024® module On request when placing the order)	
Quantities	up to 12 to be selected from output quantities (anemometric, compass, meteo).
Range	0-20mA, 4-20mA, 0÷5V, 0÷10V
Resolution	14bits
Output Rate	Normal mode (Slow): 1 ÷ 3600 sec Analog High Frequency (Fast) : from 5Hz to 20Hz depending on the baud rate
Power Supply	
Range	12 ÷ 30 Vdc
Power	< 2W - (Typically: 110mA @ 15Vdc) < 6W - Models with heaters and environment temperature not lower than -10 °C
General	
Weight	HD2003 : 2.1Kg HD2003.1 : 1.5Kg
Temperature Range	-40 +60°C
Precipitation	Operation ensured up to 300mm/hr of water
Humidity	0% ÷ 100% RH

Heaters Option

Heating with automatic temperature control on sonic transducers, to prevent ice and snow formation and ensure a correct functioning even when sleeting or snowing.

RS422 Option (On request when placing the order).

Integrated circuit for communication RS422 4-wire full duplex.

Technical specifications of the pressure - temperature and relative humidity sensors (HD2003 model)

Temperature	
Sensor	Pt100
Analog Output	0-20 mA, 4-20 mA, 0÷1V, 0÷5V, 0÷10V, 1÷5V
Analog Output Extended (AoXnd)	0-20mA, 4-20mA, 0÷5V, 0÷10V
Range	-40°C + 60°C
Resolution	0.1 °C
Accuracy	± 0.2 °C, ±0.15% of reading

Pressure

Sensor	Piezo Resistive
Analog Output	0-20 mA, 4-20 mA, 0÷1V, 0÷5V, 0÷10V, 1÷5V
Analog Output Extended (AoXnd)	0-20mA, 4-20mA, 0÷5V, 0÷10V
Range	600 ÷ 1100 mbar
Resolution	0.1 mbar
Accuracy	± 0.4 mbar @20 °C
Temperature Effects	± 0.8 mbar between -40 °C and +60 °C
Long-term stability	1mbar in 6 months @ 20 °C

Relative Humidity

Capacity sensor	H6100
Analog Output (0% ÷ 100% RH)	0-20 mA, 4-20 mA, 0÷1V, 0÷5V, 0÷10V, 1÷5V
Analog Output Extended (AoXnd)	0-20mA, 4-20mA, 0÷5V, 0÷10V
Range	5÷98% RH
Resolution	0.1 %
Accuracy	± 2.5% RH @ 23°C

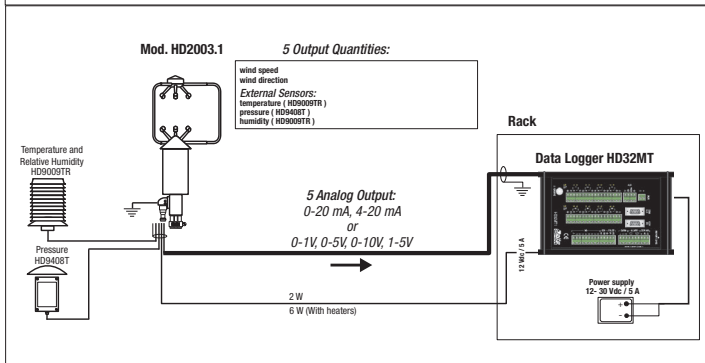
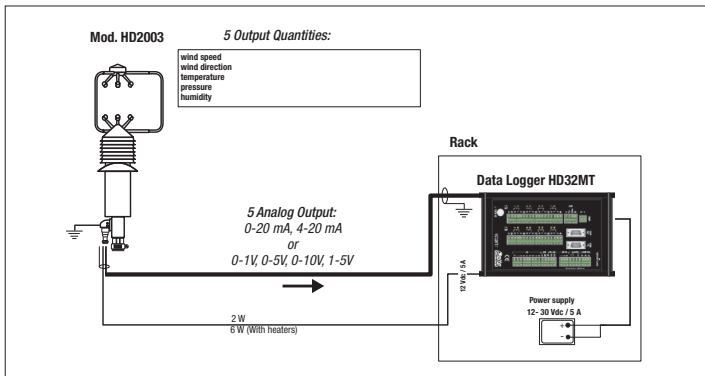
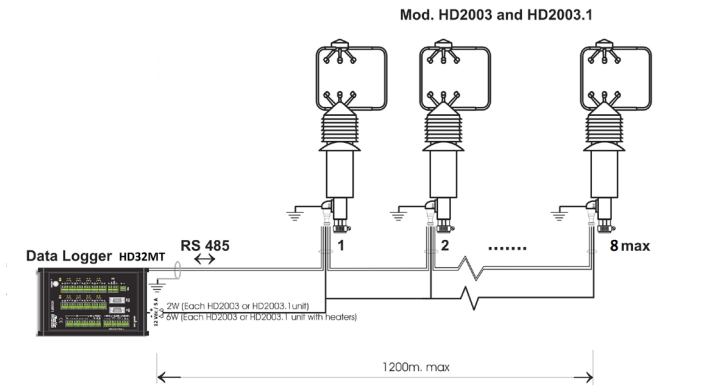
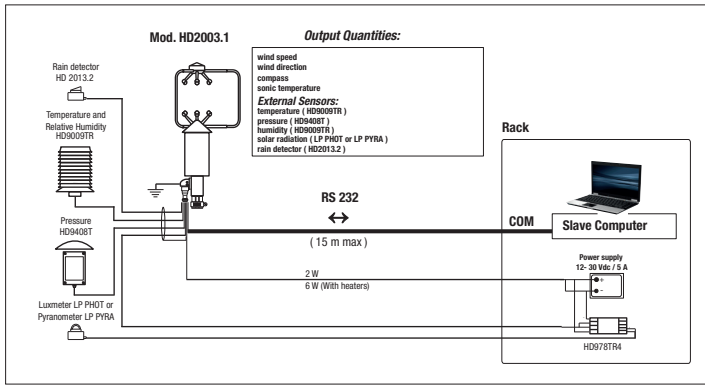
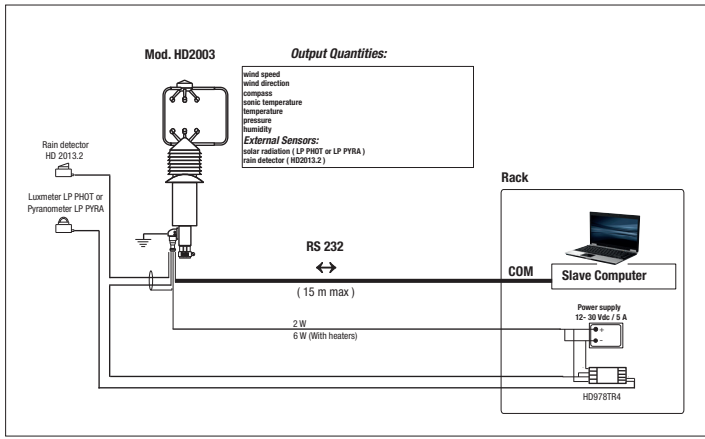

ORDERING CODES:

HD2003: Static anemometer for measuring the speed and direction of wind, air temperature, relative humidity and barometric pressure. wind speed and direction, U-V-W Cartesian Components of speed, wind gust, sound speed, sonic temperature. Five different analogue voltage or current outputs for different ranges. Communication software for bi-directional links for net connection of different anemometers, interfaces available RS232, RS485, RS422. Different measuring units and average periods are available. Ultrasonic transducers heating as optional. 12..30 Vdc power supply, 120mA consumption at 15Vdc. To be mounted on a mast diam.33mm. Flying connector included.

HD2003R: Transducers heating option for HD 2003 against ice or snow.

HD2003.1: Static anemometer for measuring the speed and direction of wind. Wind speed and direction, U-V-W Cartesian Components of speed, wind gust, sound speed, sonic temperature. Five different analogue voltage or current outputs for different ranges. Communication software for bi-directional links for net connection of different anemometers, interfaces available RS232, RS485, RS422. Different measuring units and average periods are available. Transducers heating as optional. 12..30 Vdc power supply, 120mA consumption at 15Vdc. To be mounted on a mast diam.33mm. Flying connector included.

HD2003.1R: Transducers heating option for HD 2003.1 against ice or snow.

Please specify also the following (depending on the selected model):

- **Model HD2003 and HD2003.1:** integrated circuit for 4-wire full duplex RS422 communication.
- **Model HD2003:** if the extension of the analog outputs is required, by additional external sensors with 0÷1V analog output. In order to linearize their range on the scale 0÷1V, it is necessary to specify in this case the number of sensors that you intend to employ (max. two), and their physical range.
- **Model HD2003.1:** if the extension of the analog outputs is required by additional external sensors with 0÷1V analog output. In order to linearize their range on the scale 0÷1V, it is necessary to specify in this case the number of sensors that you intend to employ (max. five), and their physical range.

