

# Piezo ceramic elements and products view.

## Shapes of element products

### Disks

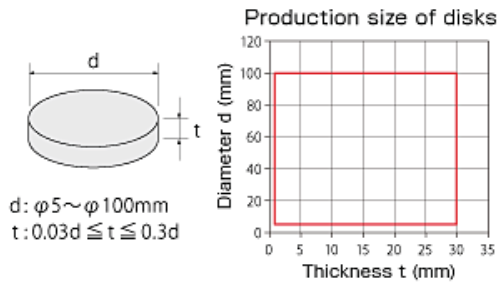

### Semicircles

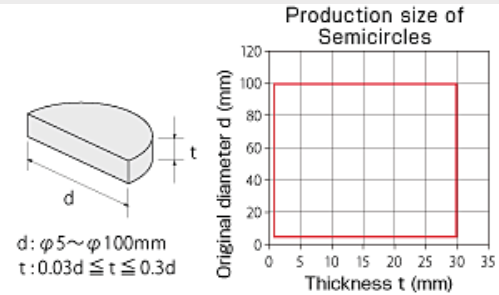

### Columnar shapes

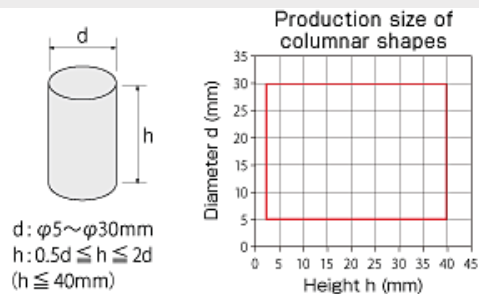
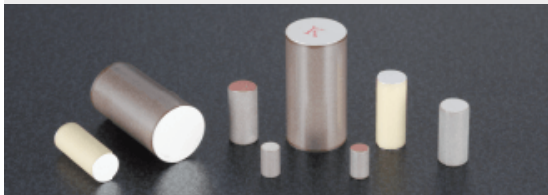

### Square plats

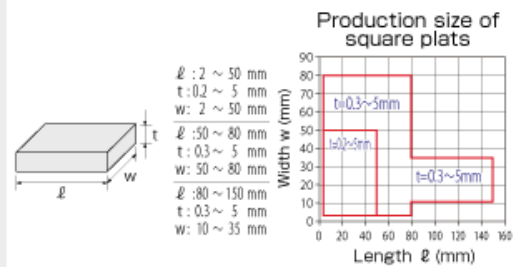
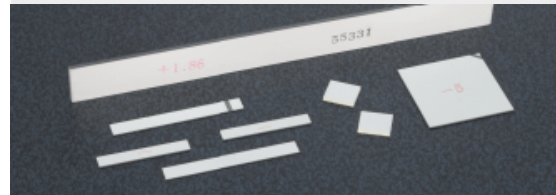

### Prismatic shapes

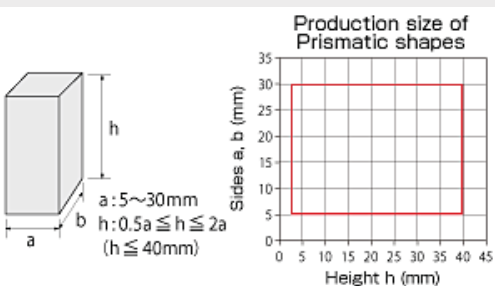
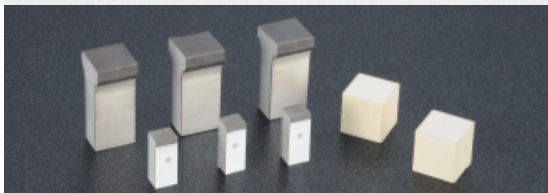

### Annular shapes

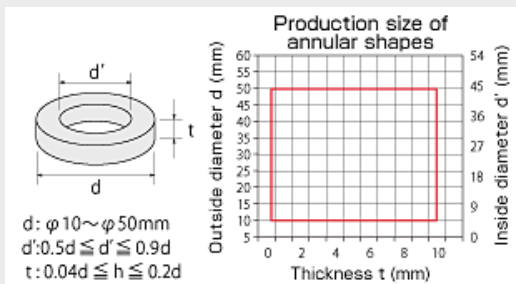

### Cylindrical shapes

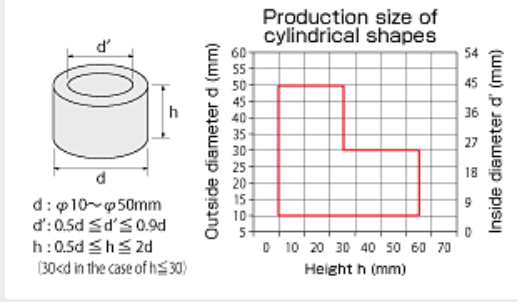

### Spherical shapes

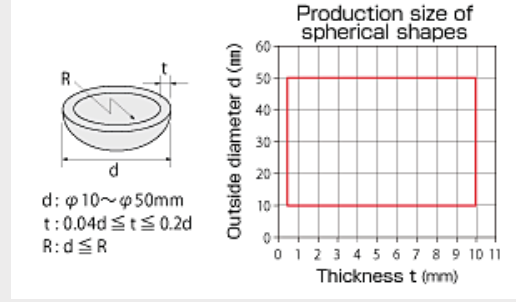

### Half-cylindrical types

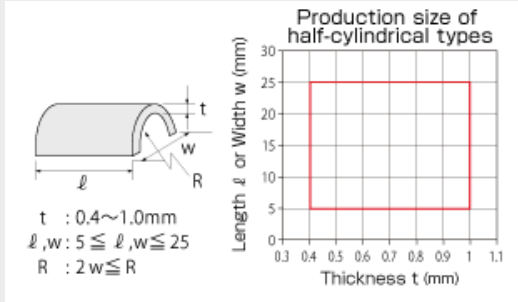

### Other special shapes

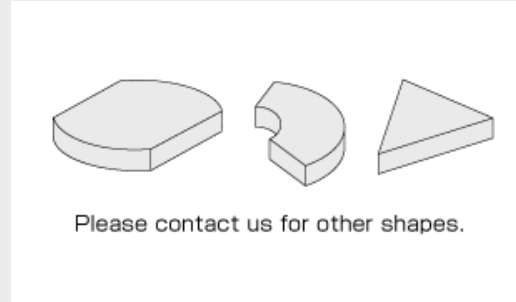
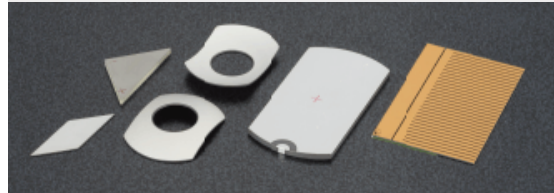

### Multilayer piezo elements

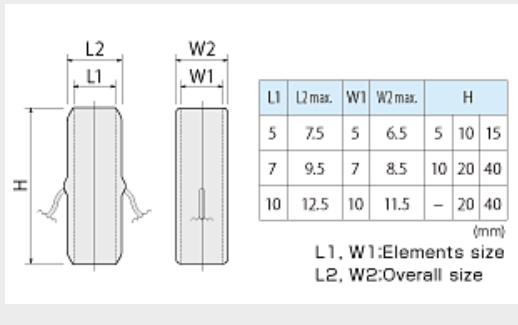
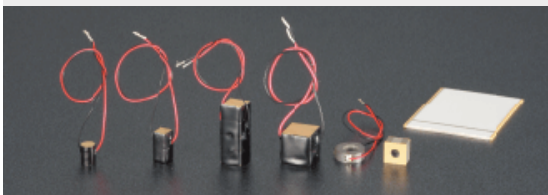

### Composite piezo elements

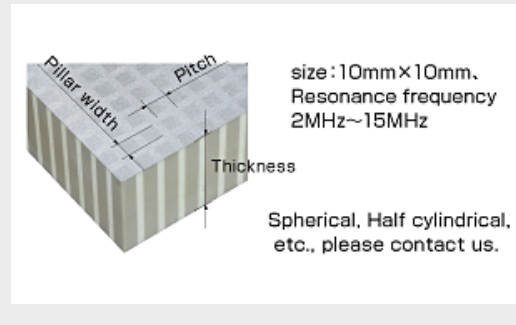
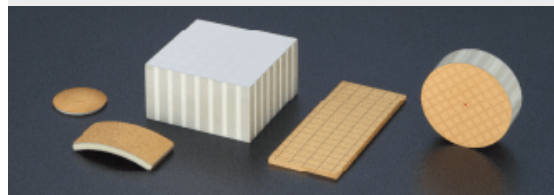

Production is possible size depends on the ceramic material and specifications.  
 For out-of-range size, please contact us.